

Aufbauanleitung Assembly Instructions







Strandkorb

Type



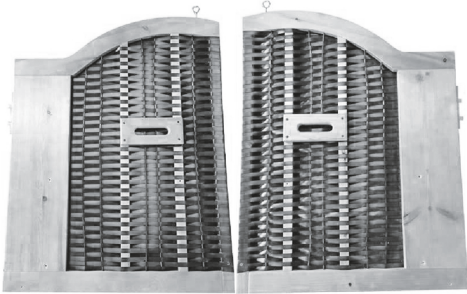

Beach Chair

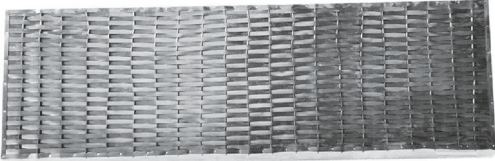
KD2BBL



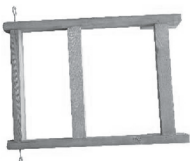

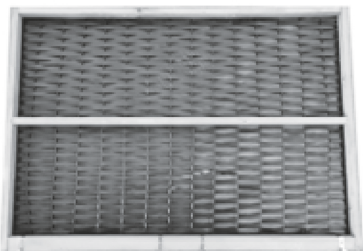
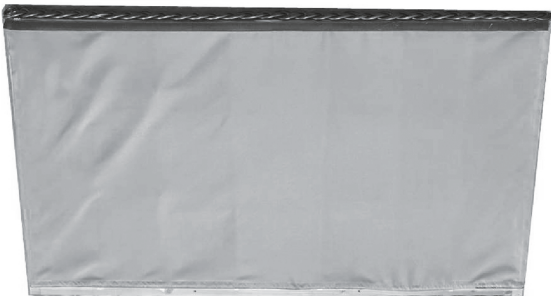

KD2BBL- INSTRUCTION

TEILELISTE / PART LIST	Deutsch / English	
Bild / Picture	Bezeichnung / Description	Anzahl
	<p>P1: Linkes unteres Seitenteil P1: Left lower side part</p> <p>P2: Rechtes unteres Seitenteil P2: Right lower side part</p>	<p>1</p> <p>1</p>
	<p>P3: Sitzschienen P3: Seat slates</p>	<p>4</p>
	<p>P4: Seitenteile P4: Side slates</p>	<p>2</p>
	<p>P5: Fußteil P5: Foot board</p>	<p>1</p>
	<p>P6: Sitzfront P6: Seat front</p>	<p>1</p>
	<p>P7: Sitzlehne Unterstützung P7: Seat back support</p>	<p>1</p>

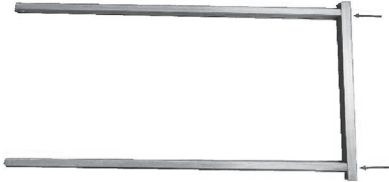







KD2BBL- INSTRUCTION

TEILELISTE / PART LIST		Deutsch / English	
Bild / Picture		Bezeichnung / Description	Anzahl
 <p>P8</p>	 <p>P9</p>	<p>P8: Fußstütze vorne P8: Footrest front</p> <p>P9: Fußstütze Rahmen P9: Footrest frame</p>	<p>1</p> <p>1</p>
		<p>P10: Obere Rückenlehne P10: Upper backrest</p>	<p>1</p>
		<p>P11: Untere Rückenlehne P11: Lower backrest</p>	<p>1</p>
		<p>P12: Dach P12: Roof</p>	<p>1</p>
		<p>P13: Linkes oberes Seitenteil P13: Left upper side part</p> <p>P14: Rechtes oberes Seitenteil P14: Right upper side part</p>	<p>1</p> <p>1</p>

KD2BBL- INSTRUCTION

TEILELISTE / PART LIST	Deutsch / English	
Bild / Picture	Bezeichnung / Description	Anzahl
	<p>P15: Markise P15: Marquee</p>	<p>1</p>
	<p>P16: U-Halterung Seite P16: U-Support side</p> <p>P17: U-Halterung Basis P17: U-Support base</p>	<p>2</p> <p>1</p>
<p>C1</p>  	<p>C1: Fußstützenkissen C1: Footrest cushion</p> <p>C2: 10CM Fußstützenkissen C2: 10CM footrest cushion</p>	<p>2</p> <p>2</p>
  <p>C4</p>	<p>C3: Nackenkissen C3: Neck cushion</p> <p>C4: Kissen C4: Pillow</p>	<p>2</p> <p>2</p>
 	<p>C5: Rückenlehnenkissen C5: Backrest- cushion</p> <p>C6: Sitzkissen C6: Seat cushion</p>	<p>2</p> <p>1</p>

Liste der Metallteile

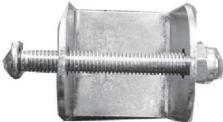
TEILELISTE / PART LIST		Anzahl	TEILELISTE / PART LIST		Anzahl
S1	 5x45mm	26	S2	 4X35CM	14
S3	 4X25CM	24	M1	 Markiese Unterlegscheiben  Marquee shims	4
M2		2	M3	 4 Stk	4
M4	 2 Sets	2	M5	 2 Sets	2

Schritte zum Zusammenbauen Assembling steps

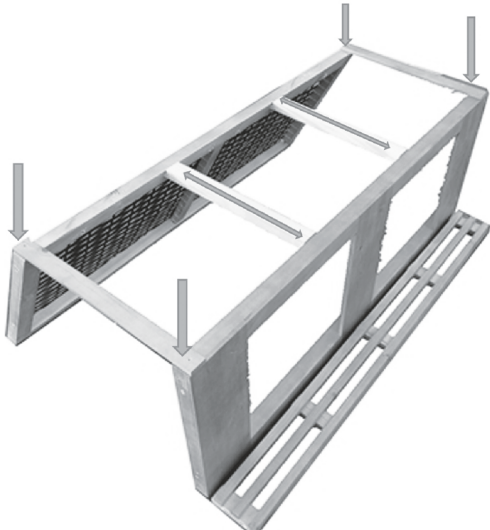

4x25MM 2Stk. AN JEDER SEITE
4x25MM 2PCS. EACH SIDE

Schritt 1: Verwenden Sie P3, um P6 mit P7 zu verbinden, und befestigen Sie dann P4 an P6/P7 mit 4 St. S3
STEP 1: Use P3 connect P6 with P7 and then fix P4 to P6/P7 with 4PCS S3

SCHRITT 2: Befestigen Sie P1 / P2 mit 12 Stk S1 am Sitzrahmen

STEP 2: Fix P1/P2 to the seat frame by 12 PCS S1

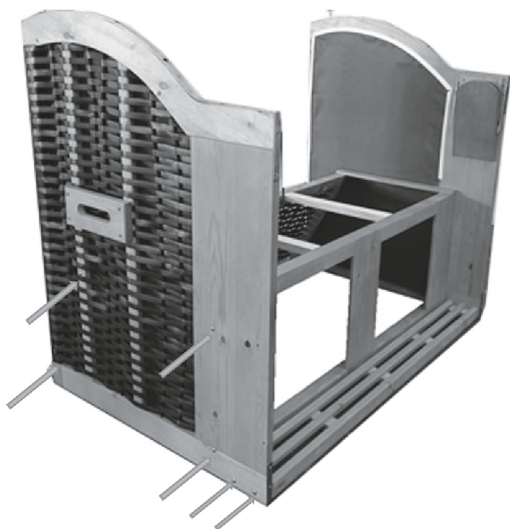

5x45MM 6 Stk auf jeder Seite

5x45MM 6 PCS each side

SCHRITT 3: Aufstellen der Fußstütze

STEP 3: Set up the footrest

Befestigen Sie P8 an P9 mit je 4 Stk S2

Fix P8 to P9 with 4PCS S2 each set

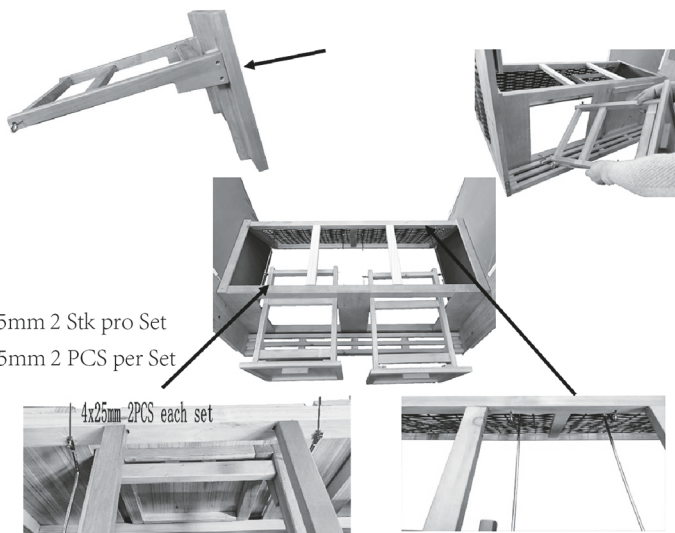

4x25mm 2 Stk pro Set

4x25mm 2 PCS per Set

4x25mm 2PCS each set

Schritt 4: Oberteil einrichten
Step 4: Setup the upper part



4x35MM 2 Stk
4x35MM 2 PCS

4x35MM 2 Stk
4x35MM 2 PCS

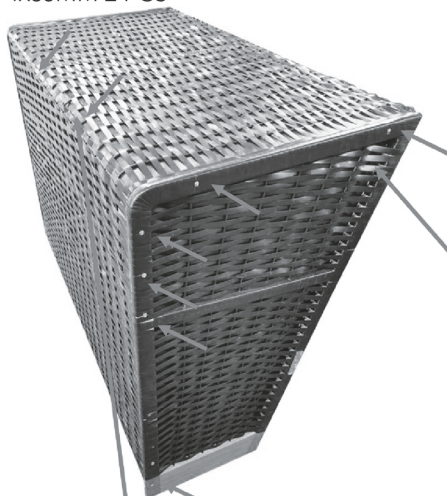

Befestigen Sie die
Markiese mit 5x45MM

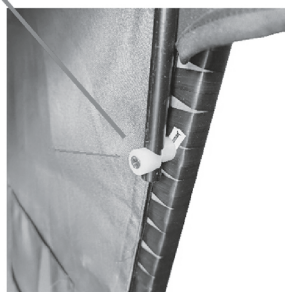

Schritt 5: Rückenstütze aufstellen, P16 mit P17 durch S2(4X35MM)Schrauben verbinden

Step 5: Set up back support, connect P16 with P17 by S2(4X35MM) screws

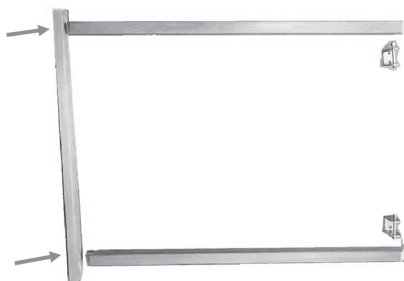

Befestigen Sie das M5- Metall mit 4X25MM- Schrauben am hinteren Rahmen und verbinden Sie die Schraube.

Use 4X25MM screws fix the M5 metal on the back frame and connect the bolt.

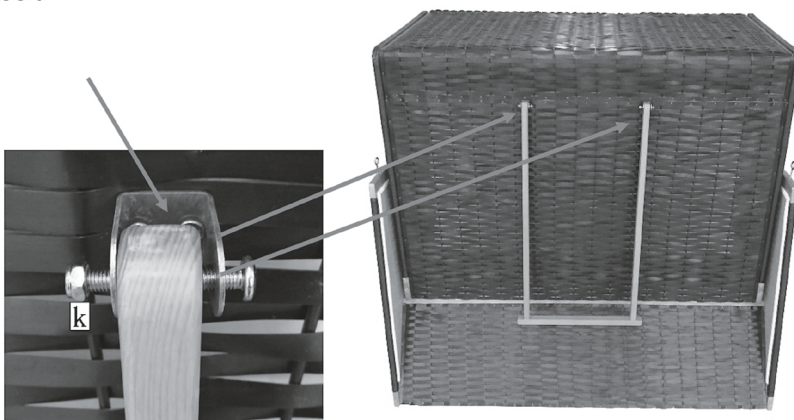

Schritt 6: Verwenden Sie 12 St. S3, um das Scharnier am oberen Teil und am Sitzrahmen zu befestigen, verbinden Sie den Griff.

Step 6: Use 12 PCS S3 fix the hinge to the upper part and seat frame, connect t connect the handle.

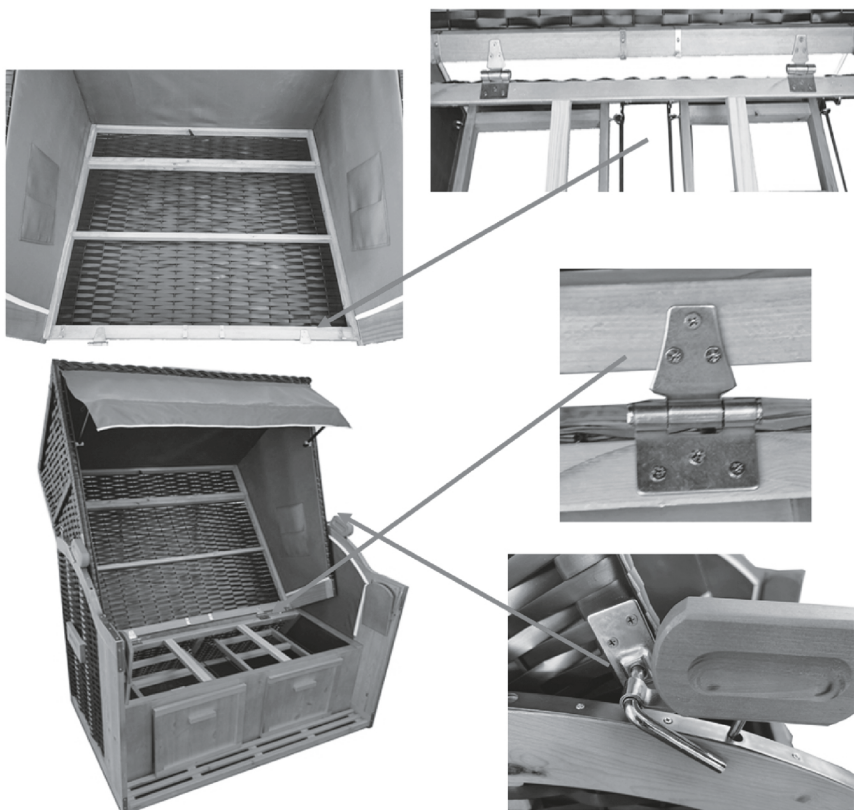

Schritt 7: Legen Sie alle Kissen auf
Step 7: put on all the cushions

