

# Aufbauanleitung Assembly Instructions



**Strandkorb**

Type

**Beach Chair**

**KD4BBX**

## AUFBAUHINWEISE

## DEUTSCH

### Bitte prüfen Sie vor Beginn der Montage alle Teile und Schrauben auf Vollständigkeit

- Idealerweise erfolgt der Aufbau zu zweit.
- Zur Montage benötigen Sie lediglich einen stabilen Kreuzschlitz-Schraubendreher, oder besser einen Akkuschrauber mit guten (neuen) Kreuz-Bits (PH2).
- Bitte stellen Sie den Akkuschrauber auf ein mittleres Drehmoment, um ein Überdrehen der Schraubenköpfe zu verhindern. Drehen Sie anfangs alle Schrauben nur zu 2/3 ein – ziehen Sie sie erst fest nachdem sämtliche Schrauben vorfixiert sind.

## PFLEGEHINWEISE

## DEUTSCH

### Wenn Sie sich an alle Instruktionen halten, werden Sie lange Freude an Ihrem neuen Strandkorb haben

- Zum Wetterschutz ist unter dem Geflecht des Daches eine Folie angebracht, die vor Regen schützt. Auf der Sitzbank ist der fest verbundene Stoff gegen Witterung imprägniert.
- Stoff, der fest mit dem Strandkorb verbunden ist, können Sie bei Verschmutzungen mit reinem Wasser oder milder Seifenlauge vorsichtig reinigen; abnehmbare Stoffe können in der Waschmaschine Stufe „pflegeleicht bis 40°“ gereinigt werden.
- Zur Pflege des Holzes können Sie dieses bei Bedarf, mindestens einmal im Jahr, mit Holzschutz-Lasur behandeln.

## ASSEMBLY HINTS

## ENGLISH

- **Please check before the assembly all parts and screws for completeness**
- Ideally, the assembly takes place in pairs.
- For installation you only need a stable Phillips screwdriver, or even better a cordless screwdriver with good (new) Cross-bits (PH2).
- Please adjust the cordless screwdriver to an average torque to prevent overwinding of the screw heads. In the beginning, please turn all the screws only 2/3 into the beachchair pull them firmly after all the bolts are pre-fixed.

## MAINTENANCE HINTS

## ENGLISH

### If you follow all the instructions, you will prolong the enjoyment of your new beach chair





- For weather protection under the wicker of the roof a film is attached, that protects against rain. The fixed material on the seatbench is impregnated.
- Fabric which is connected to the beachchair, can easily be cleaned with pure water or a mild soapy solution; Removable materials can be „easy to care for up to 40°“ cleaned in the washing machine.
- To take care of the wood you can treat this, if necessary, at least once a year, with a wood stain.

Bei Fragen wenden Sie sich gerne an unseren Kundenservice.



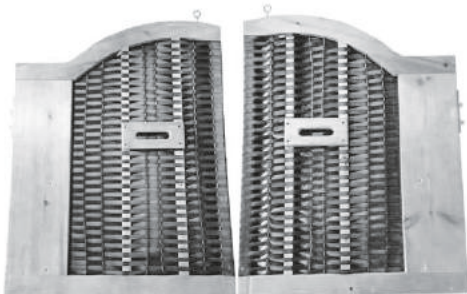

Telefon: 040 6963244 80

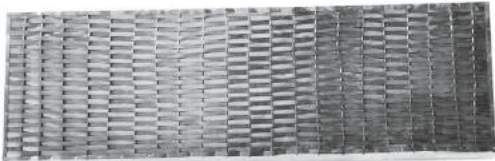
E-Mail: info@strandkorb-hanse.de



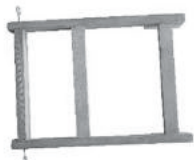
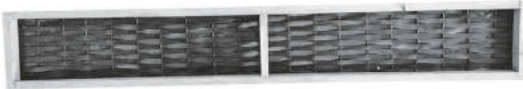
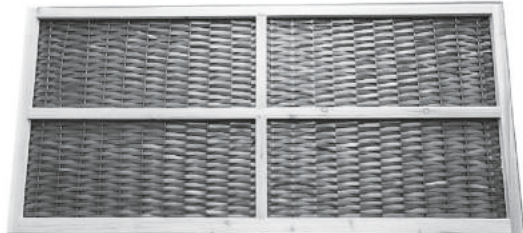

## KD4BBX- INSTRUCTION

TEILELISTE / PART LIST		Deutsch / English
Bild / Picture	Bezeichnung / Description	Anzahl
	P1: Linkes unteres Seitenteil P1: Left lower side part	1
	P2: Rechtes unteres Seitenteil P2: Right lower side part	1
	P3: Sitzschienen P3: Seat slates	4
	P4: Seitenteile P4: Side slates	2
	P5: Fußteil P5: Foot board	1
	P6: Sitzfront P6: Seat front	1
	P7: Sitzlehne Unterstützung P7: Seat back support	1





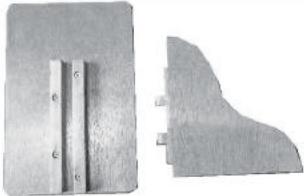

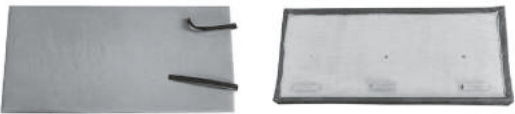

# KD4BBX- INSTRUCTION

TEILELISTE / PART LIST		Deutsch / English	
Bild / Picture		Bezeichnung / Description	Anzahl
 <p><b>P8</b></p>	 <p><b>P9</b></p>	P8: Fußstütze vorne P8: Footrest front	1
		P9: Fußstütze Rahmen P9: Footrest frame	1
		P10: Obere Rückenlehne P10: Upper backrest	1
		P11: Untere Rückenlehne P11: Lower backrest	1
		P12: Dach P12: Roof	1
		P13: Linkes oberes Seitenteil P13: Left upper side part	1
		P14: Rechtes oberes Seitenteil P14: Right upper side part	1

# KD4BBX- INSTRUCTION

TEILELISTE / PART LIST		Deutsch / English	
Bild / Picture	Bezeichnung / Description	Anzahl	
	P15: Markise P15: Marquee	1	
	P16: U-Halterung Seite P16: U-Support side  P17: U-Halterung Basis P17: U-Support base	2  1	
	P18: Wendetisch SETS P18: Turning table SETS	2	
	C1: Fußstützenkissen C1: Footrest cushion  C2: 10CM Fußstützenkissen C2: 10CM footrest cushion	2  2	
	C3: Nackenkissen C3: Neck cushion  C4: Kissen C4: Pillow	2  2	
	C5: Rückenlehnenkissen C5: Backrest- cushion  C6: Sitzkissen C6: Seat cushion	3  1	

## Liste der Metallteile

TEILELISTE / PART LIST		Anzahl	TEILELISTE / PART LIST		Anzahl
S1	 5x45mm	26	S2	 4X35CM	14
S3	 4X25CM	32	M1	 Markiese Unterlegscheiben Marquee shims	4
M2		2	M3	 4 Stk	4
M4	 Sets	2	M5	 Sets	2

## Schritte zum Zusammenbauen Assembling steps

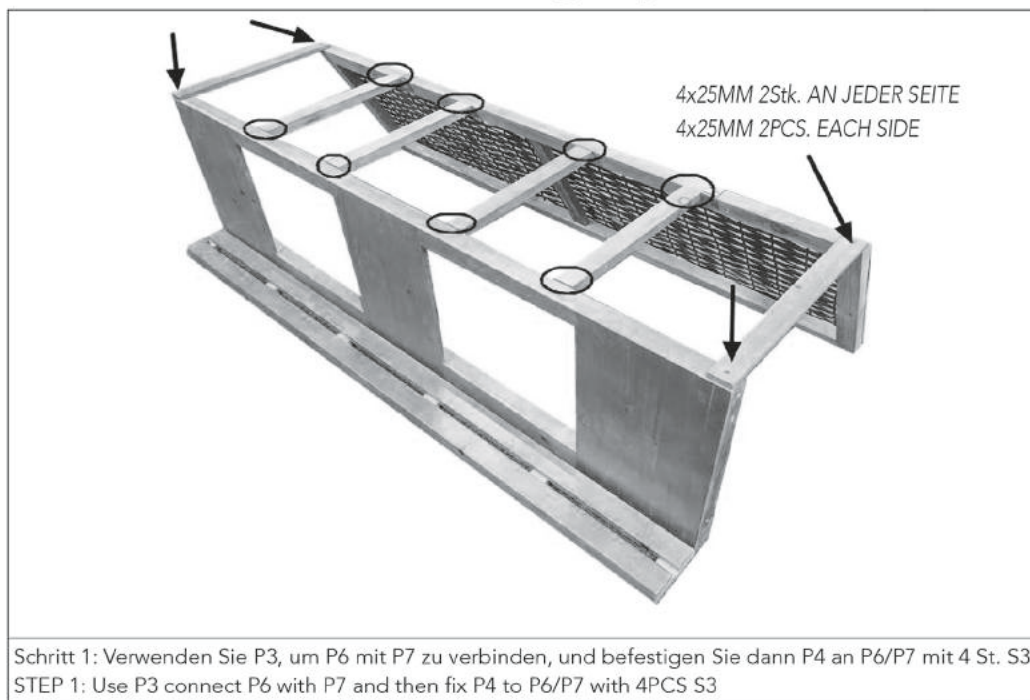

SCHRITT 2: Befestigen Sie P1 / P2 mit 12 Stk S1 am Sitzrahmen

STEP 2: Fix P1/P2 to the seat frame by 12 PCS S1

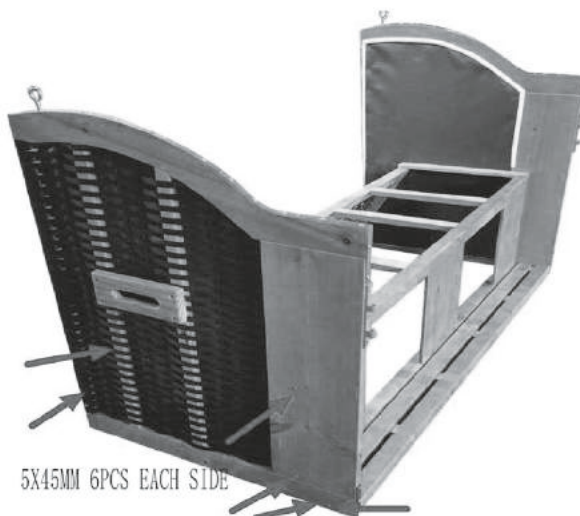

SCHRITT 3: Aufstellen der Fußstütze

STEP 3: Set up the footrest

Befestigen Sie P8 an P9 mit je 4 Stk S2  
Fix P8 to P9 with 4PCS S2 each set

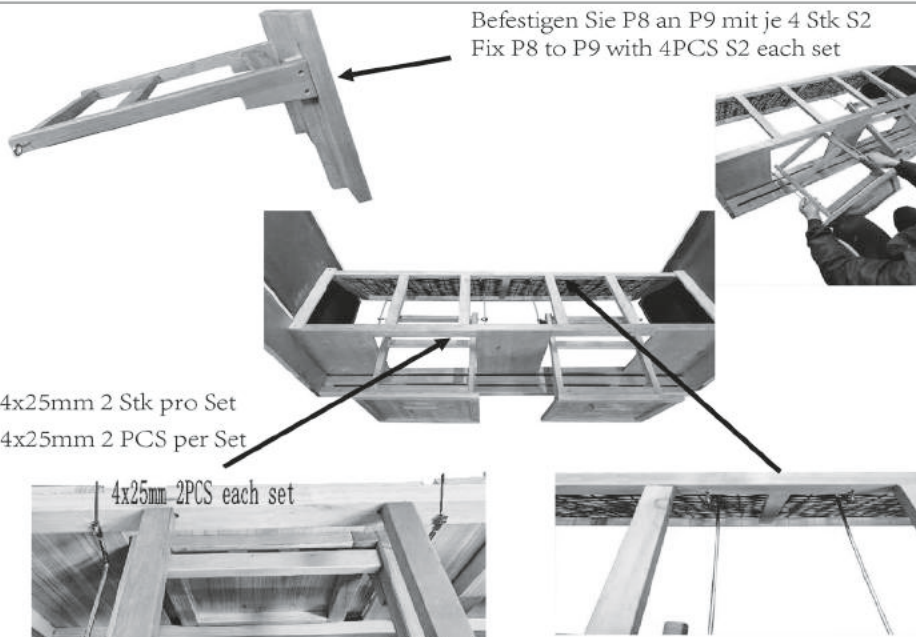

Schritt 4: Oberteil einrichten  
Step 4: Setup the upper part

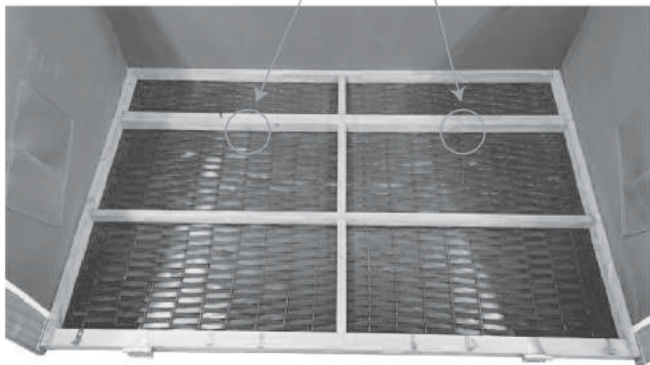
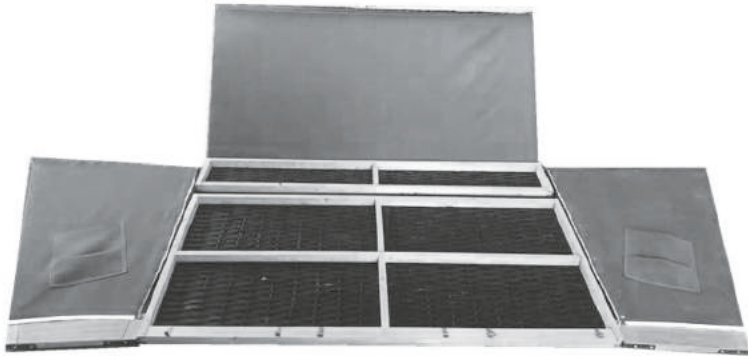



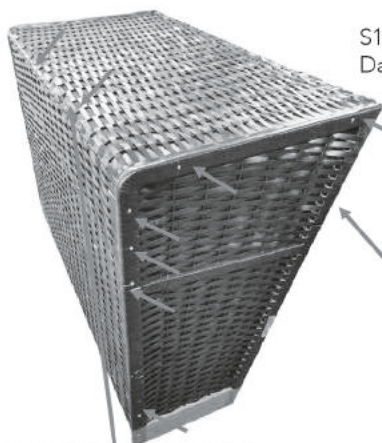

S1 6 St. pro Seite, S2 2 St. zur Verbindung des Daches mit der Rückseite

S1 6PCS each side, S2 2PCS for connecting the roof to back

Befestigen Sie die Markise mit 5X45MM-Schrauben und M1-Unterlegscheiben

Fix the Marquee with 5X45MM screws and M1 shims

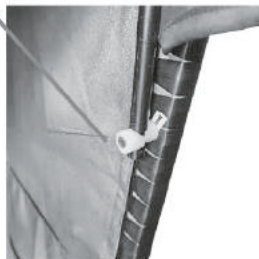

Schritt 5: Rückenstütze aufstellen, P16 mit P17 durch S2(4X35MM)Schrauben verbinden

Step 5: Set up back support, connect P16 with P17 by S2(4X35MM) screws

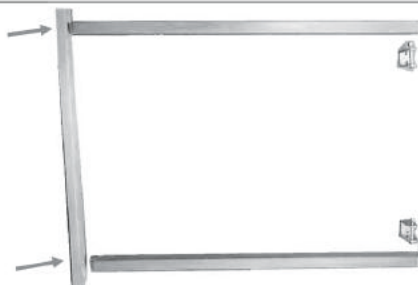

Befestigen Sie das M5- Metall mit 4X25MM- Schrauben am hinteren Rahmen und verbinden Sie die Schraube.

Use 4X25MM screws fix the M5 metal on the back frame and connect the bolt.

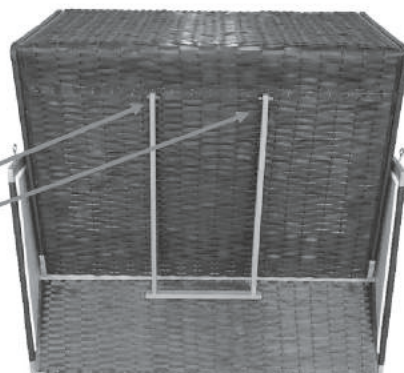
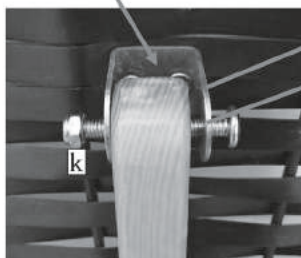

Schritt 6: Verwenden Sie 12 St. S3, um das Scharnier am oberen Teil und am Sitzrahmen zu befestigen, verbinden Sie den Griff.

Step 6: Use 12 PCS S3 fix the hinge to the upper part and seat frame, connect t connect the handle.

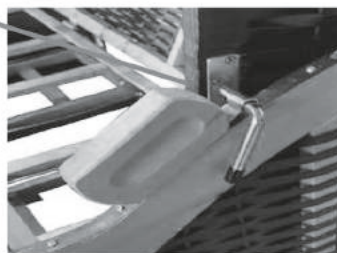
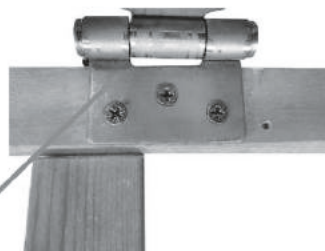

Schritt 7: Legen Sie alle Kissen auf  
Step 7: put on all the cushions

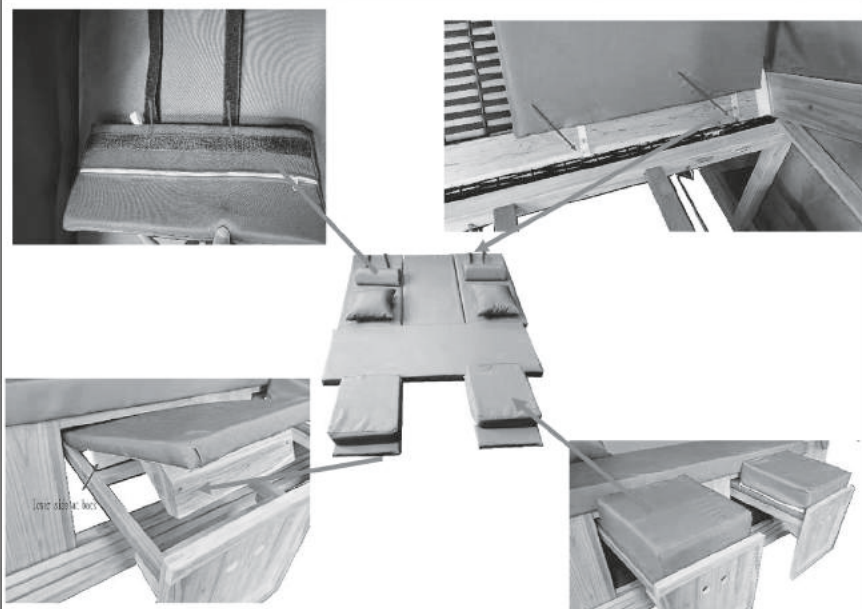

Schritt 8: Montieren Sie den Wendetisch mit je 4 St. S3.  
Step 8: Assemble the turning table with 4PCS S3 each set.

